



The Stretch Wrapping Experts

PHOENIX PRTA 2200 AUTOMATIC ROTARY ARM MACHINE SPECIFICATIONS

PERFORMANCE

Production Speed	Up to 60-80 pallets per hour
Maximum Load Size	52" x 52" x 80" load size (74" Diagonal)
Maximum Load Weight	4000 lbs (1814 kg)

LOAD HANDLING

Wrapping Speed (Variable)	25 RPM
---------------------------	--------

SERVICE REQUIREMENTS

Electric Service Requirements	230 VAC / 3PH / 60 HZ
Pneumatic Requirements	3 CFM @80 PSI

WARRANTY

3 Year Warranty
Lifetime warranty on the pre-stretch compound carriage rollers

The Phoenix PRTA Series Advantage

This system is perfect for any wrapping application, excelling in particular at wrapping application that requires to wrap light or unstable loads or for speeds which would otherwise cause the load to topple due to high rotation speeds. Rugged all-structural steel construction reflects the durability of this machine. HSS tubing provides a strong and light-weight arm minimizing the driving forces required to rotate the arm. The rugged conveyors have been engineered for smooth and long-lasting operation.

Please visit www.phoenixwrappers.com for more detailed information about this machine model and all its available options.

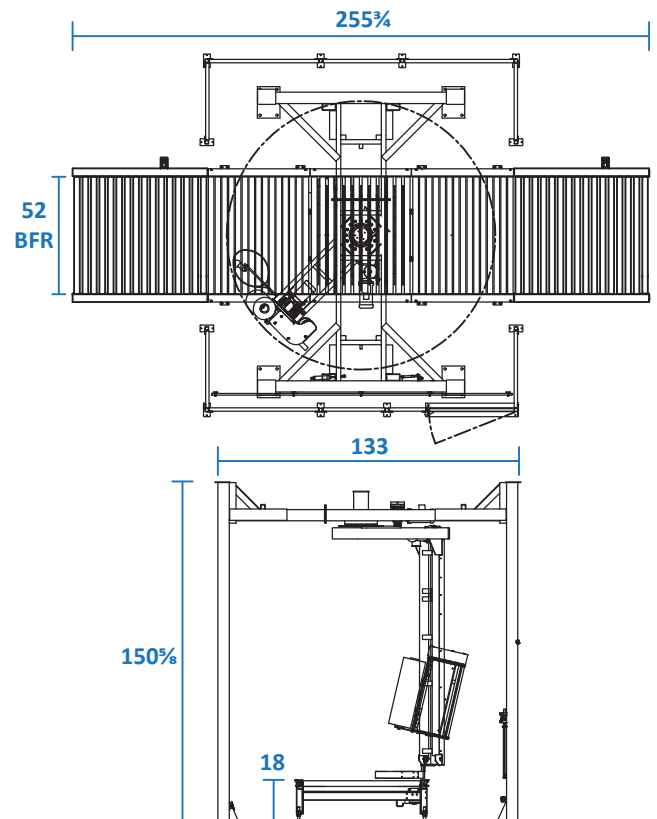

For more information call (514) 956-1525 or visit us at www.phoenixwrappers.com